

# THYRISTOR(Through Hole)

# SMG04C60

(Sensitive Gate)

**SanRex** Thyristor SMG04C60 is designed for full wave AC control applications. It can be used as an ON/OFF function or for phase control operation.

### Typical Applications

- Home Appliances : Electric Blankets, Starter for FL, other control applications
- Industrial Use : SMPS, Solenoid for Breakers, Motor Controls, Heater Controls, other control applications

### Features

- $I_{T(AV)}=0.4A$
- High Surge Current
- Low Voltage Drop
- Lead-Free Package

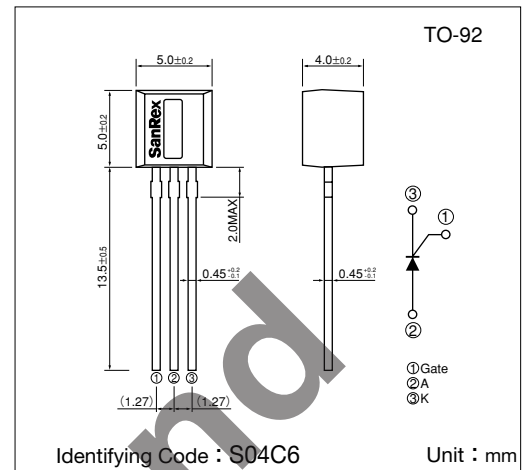

### Maximum Ratings

(T<sub>j</sub>=25°C unless otherwise specified)

Symbol	Item	Reference	Ratings	Unit
V <sub>RRM</sub>	Repetitive Peak Reverse Voltage		600	V
V <sub>RSM</sub>	Non-Repetitive Peak Reverse Voltage		720	V
V <sub>DRM</sub>	Repetitive Peak Off-State Voltage		600	V
I <sub>T(AV)</sub>	Average On-State Current	Single phase, half wave, 180°, conduction, T <sub>a</sub> =55°C	0.4	A
I <sub>T(RMS)</sub>	R.M.S. On-State Current	Single phase, half wave, 180°, conduction, T <sub>a</sub> =55°C	0.63	A
I <sub>TSM</sub>	Surge On-State Current	50/60Hz, 1/2 cycle Peak value, non-repetitive	9.1/10	A
I <sup>2</sup> t	I <sup>2</sup> t		0.4	A <sup>2</sup> S
P <sub>GM</sub>	Peak Gate Power Dissipation		0.5	W
P <sub>G(AV)</sub>	Average Gate Power Dissipation		0.1	W
I <sub>FGM</sub>	Peak Gate Current		0.3	A
V <sub>FGM</sub>	Peak Gate Voltage (Forward)		6	V
V <sub>RGM</sub>	Peak Gate Voltage (Reverse)		6	V
T <sub>j</sub>	Operating Junction Temperature		-40~+125	°C
T <sub>stg</sub>	Storage Temperature		-40~+150	°C
	Mass		0.2	g

### Electrical Characteristics

Symbol	Item	Reference	Ratings			Unit
			Min.	Typ.	Max.	
I <sub>DRM</sub>	Repetitive Peak Off-State Current	T <sub>j</sub> =125°C, V <sub>D</sub> =V <sub>DRM</sub> , R <sub>GK</sub> =1kΩ			0.5	mA
I <sub>RRM</sub>	Repetitive Peak Reverse Current	T <sub>j</sub> =125°C, V <sub>R</sub> =V <sub>RRM</sub> , R <sub>GK</sub> =1kΩ			0.5	mA
V <sub>TM</sub>	Peak On-State Voltage	I <sub>T</sub> =1.2A, Inst. measurement			1.2	V
I <sub>GT</sub>	Gate Trigger Current	V <sub>D</sub> =6V, R <sub>L</sub> =100Ω			100	μA
V <sub>GT</sub>	Gate Trigger Voltage				0.8	V
V <sub>GD</sub>	Non-Trigger Gate Voltage	T <sub>j</sub> =125°C, V <sub>D</sub> =1/2V <sub>DRM</sub> , R <sub>GK</sub> =1kΩ	0.2			V
I <sub>H</sub>	Holding Current			300		μA
R <sub>th(j-a)</sub>	Thermal Resistance	Junction to ambient			150	°C/W

Gate Characteristics

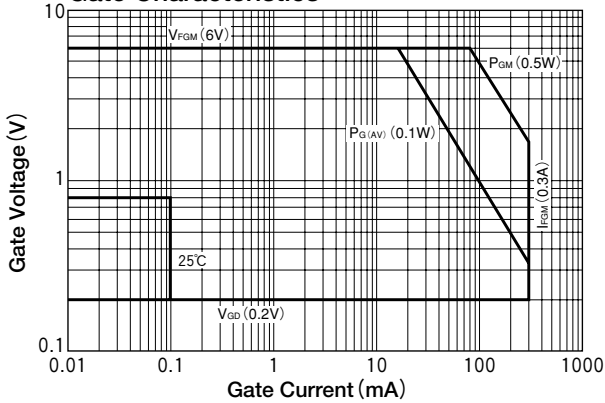

On-State Voltage (MAX)

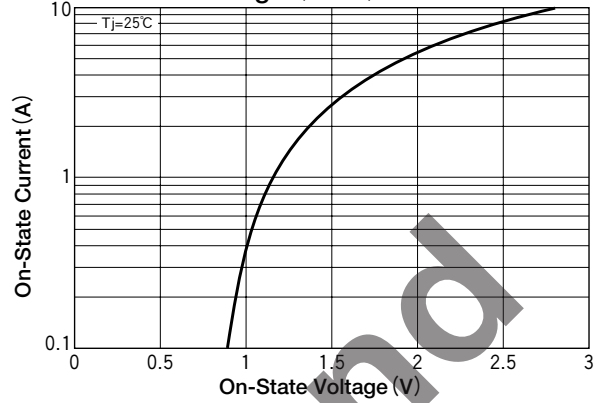

Average On-State Current vs Power Dissipation (Single phase half wave)

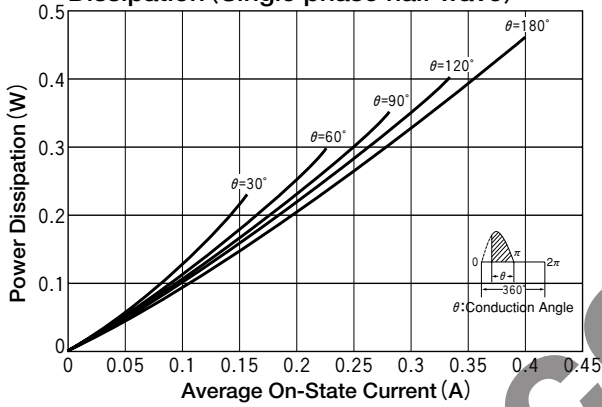

Average On-State Current vs Ambient Temperature (Single phase half wave)

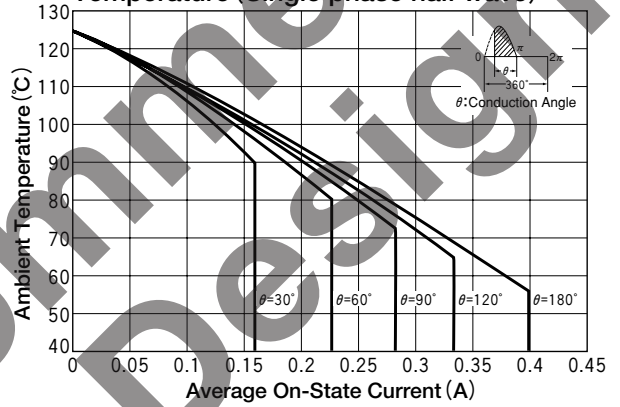

Surge On-State Current Rating (Non-Repetitive)

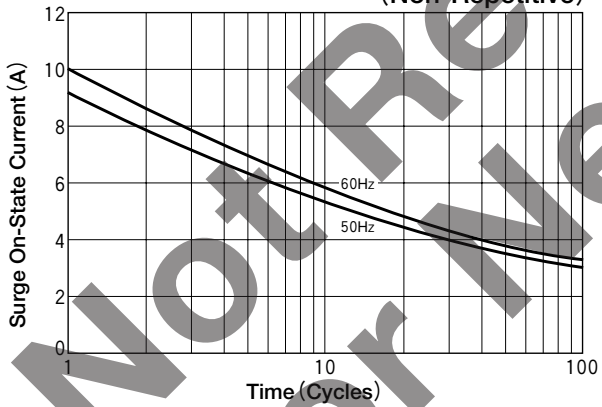

Maximum Transient Thermal Impedance Characteristics

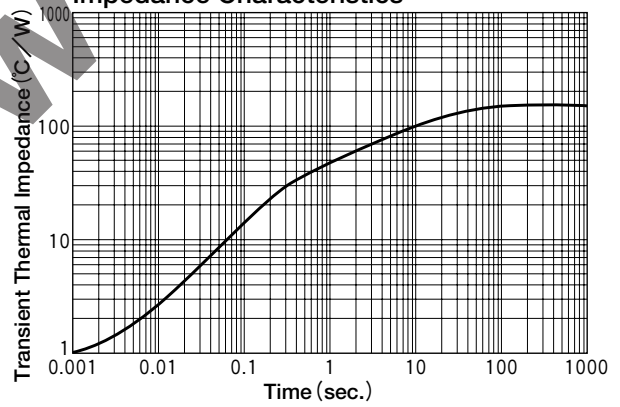

$I_{GT} - T_j$  [Change Rate] (Typical)

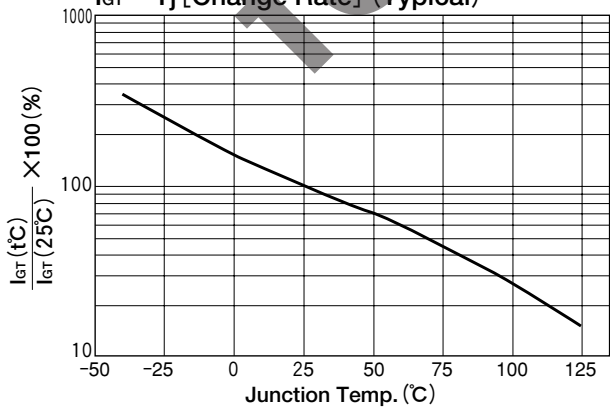

$V_{GT} - T_j$  (Typical)

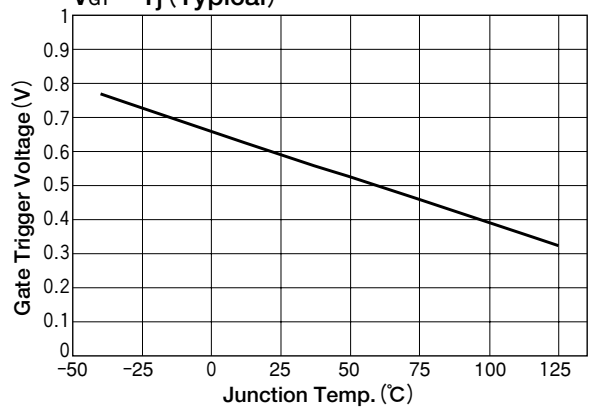

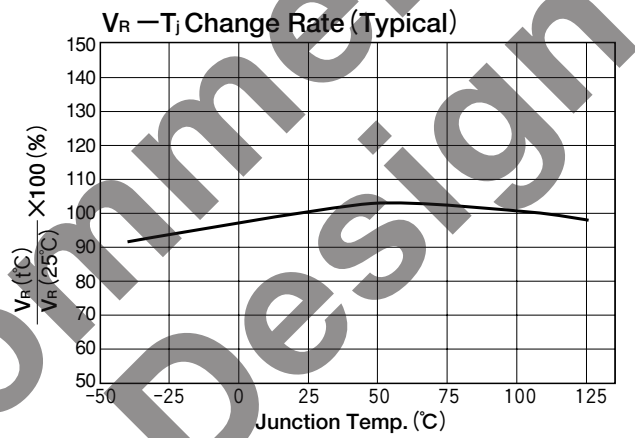
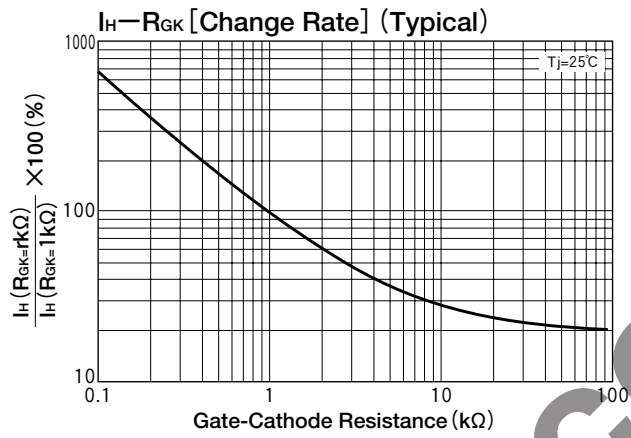
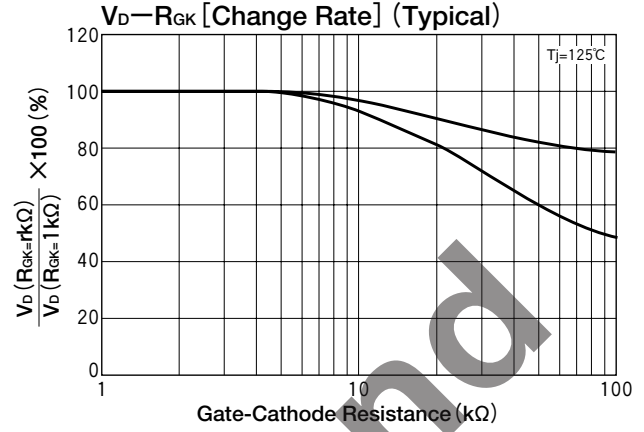
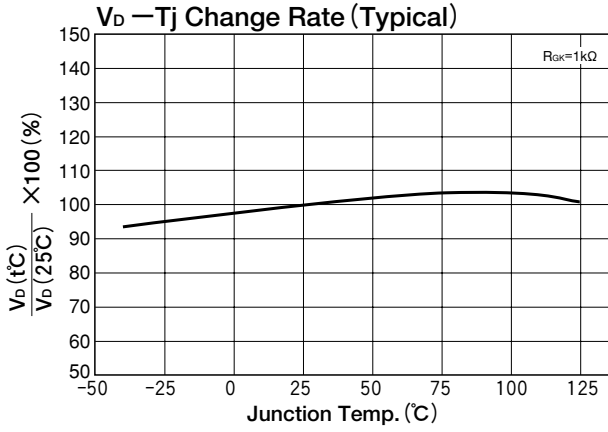

Not Recommended for New Design