

THYRISTOR(Through Hole)

SMG05C60

(Sensitive Gate)

SanRex Thyristor SMG05C60 is designed for full wave AC control applications. It can be used as an ON/OFF function or for phase control operation.

Typical Applications

- Home Appliances : Electric Blankets, Starter for FL, other control applications
- Industrial Use : SMPS, Solenoid for Breakers, Motor Controls, Heater Controls, other control applications

Features

- $I_{T(AV)}=0.5A$
- High Surge Current
- Low Voltage Drop

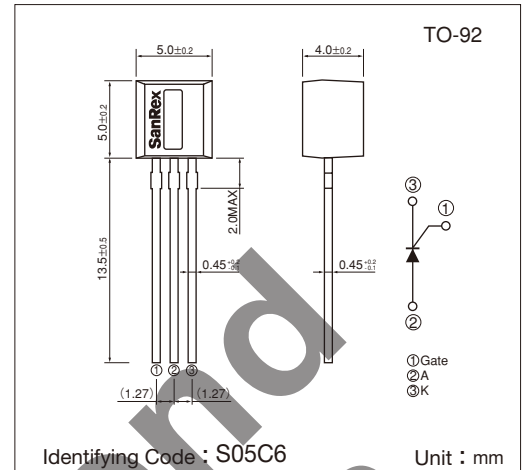

Maximum Ratings

(T_j=25°C unless otherwise specified)

Symbol	Item	Reference	Ratings	Unit
V _{RRM}	Repetitive Peak Reverse Voltage		600	V
V _{RSM}	Non-Repetitive Peak Reverse Voltage		720	V
V _{DRM}	Repetitive Peak Off-State Voltage		600	V
I _{T(AV)}	Average On-State Current	Single phase, half wave, 180°, conduction, T _a =39°C	0.5	A
I _{T(RMS)}	R.M.S. On-State Current	Single phase, half wave, 180°, conduction, T _a =39°C	0.78	A
I _{TSM}	Surge On-State Current	50/60Hz, 1/2 cycle Peak value, non-repetitive	18/20	A
I ² t	I ² t		1.65	A ² S
P _{GM}	Peak Gate Power Dissipation		0.5	W
P _{G(AV)}	Average Gate Power Dissipation		0.1	W
I _{FGM}	Peak Gate Current		0.3	A
V _{FGM}	Peak Gate Voltage (Forward)		6	V
V _{RGM}	Peak Gate Voltage (Reverse)		6	V
T _j	Operating Junction Temperature		-40~+125	°C
T _{stg}	Storage Temperature		-40~+150	°C
	Mass		0.2	g

Electrical Characteristics

Symbol	Item	Reference	Ratings			Unit
			Min.	Typ.	Max.	
I _{DRM}	Repetitive Peak Off-State Current	T _j =125°C, V _D =V _{DRM} , R _{GK} =1kΩ			0.5	mA
I _{RRM}	Repetitive Peak Reverse Current	T _j =125°C, V _R =V _{RRM} , R _{GK} =1kΩ			0.5	mA
V _{TM}	Peak On-State Voltage	I _T =1.5A, Inst. measurement			1.2	V
I _{GT}	Gate Trigger Current	V _D =6V, R _L =100Ω			100	μA
V _{GT}	Gate Trigger Voltage				0.8	V
V _{GD}	Non-Trigger Gate Voltage	T _j =125°C, V _D =1/2V _{DRM} , R _{GK} =1kΩ	0.2			V
I _H	Holding Current			300		μA
R _{th(j-a)}	Thermal Resistance	Junction to ambient			150	°C/W

Gate Characteristics

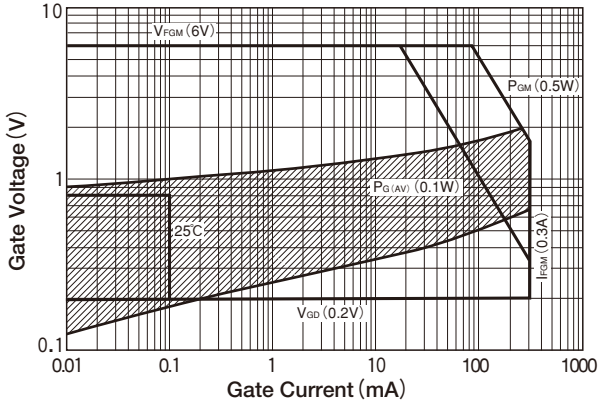

On-State Voltage (MAX)

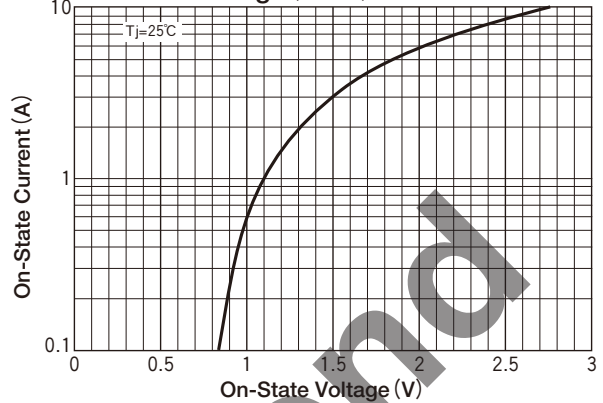

Average On-State Current vs Power Dissipation (Single phase half wave)

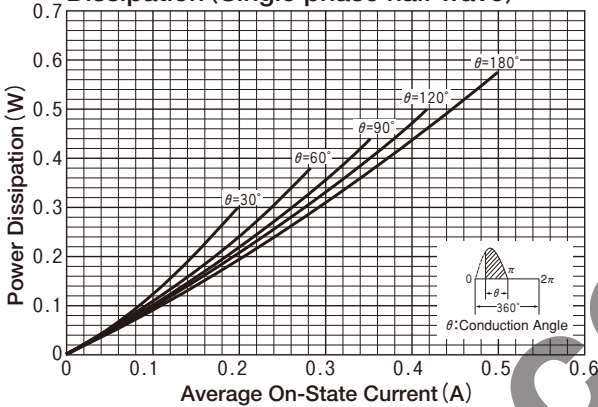

Average On-State Current vs Ambient Temperature (Single phase half wave)

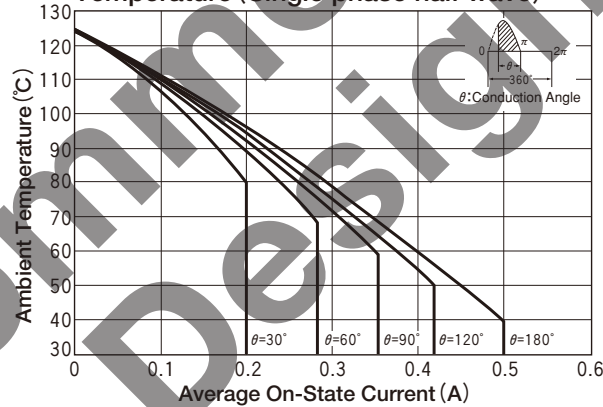

Surge On-State Current Rating (Non-Repetitive)

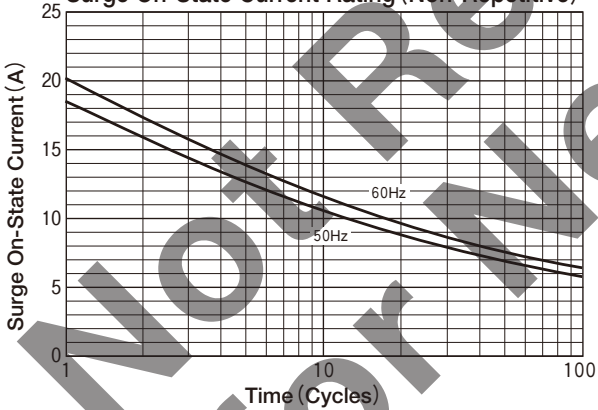

Maximum Transient Thermal Impedance Characteristics

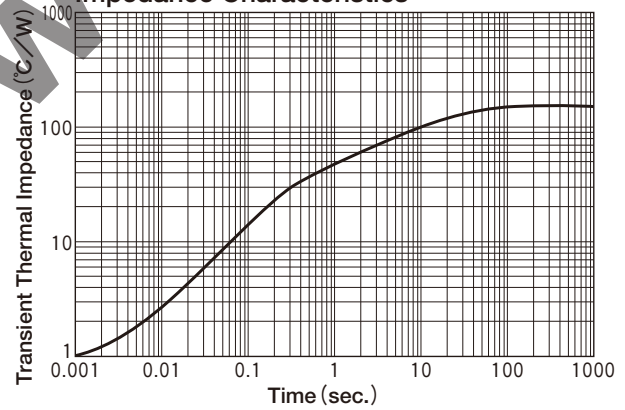

I_GT - T_j [Change Rate] (Typical)

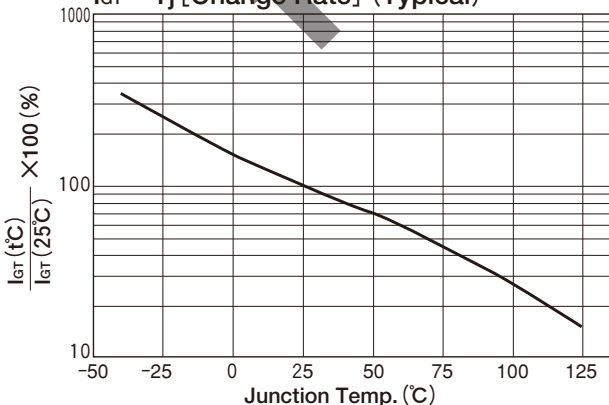

V_GT - T_j (Typical)

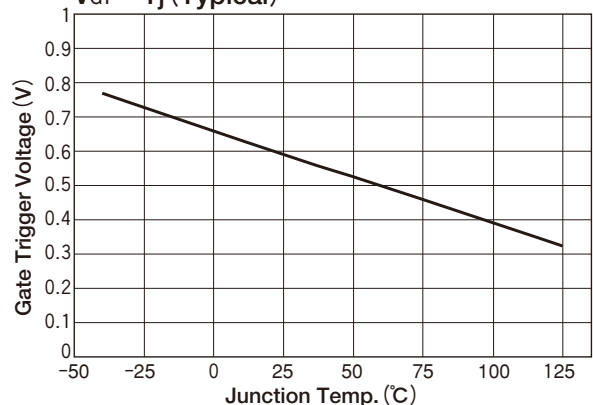

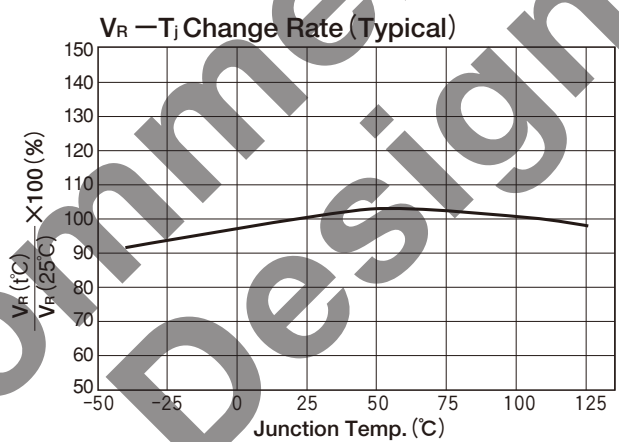
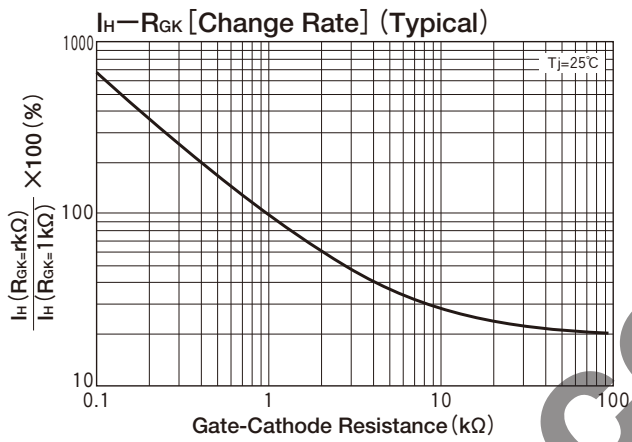
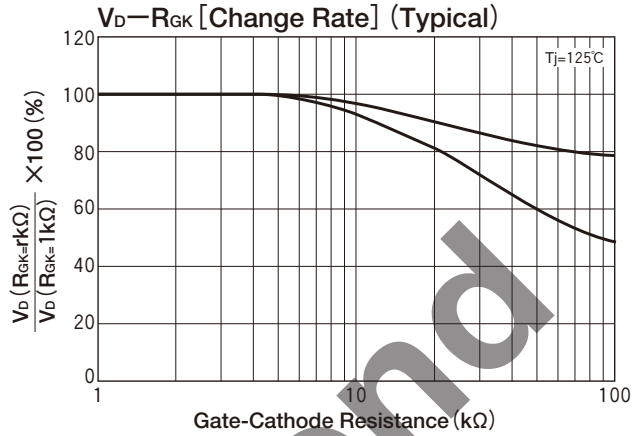
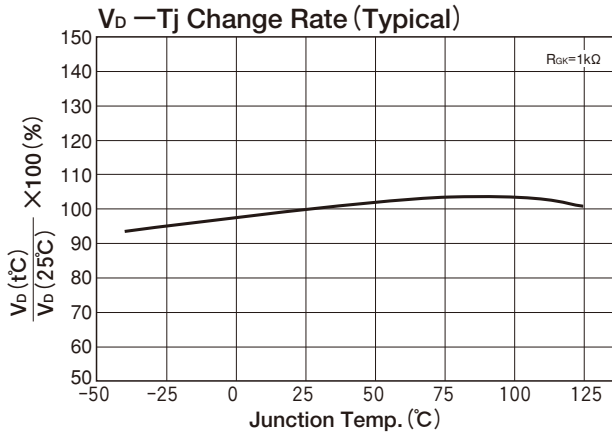

Not Recommended for New Design